

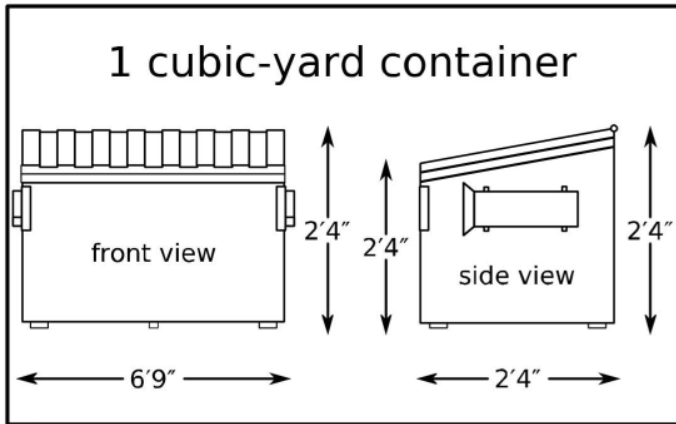

City of Watsonville Solid Waste Division

30 Day Debris Container Services 2023-2024



1 Cu Yd Refuse: \$43.29

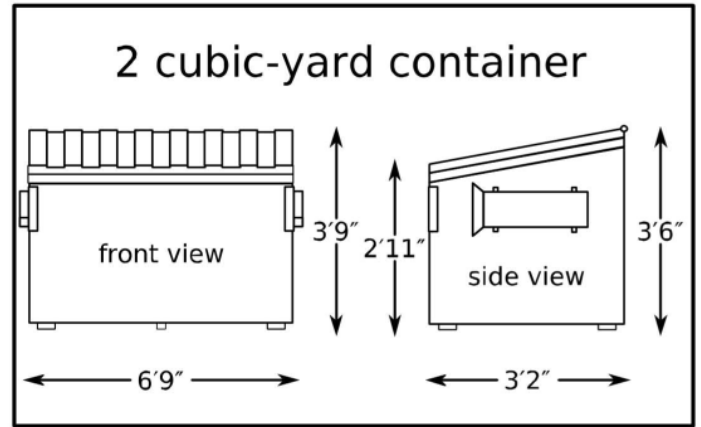

2 Cu Yd Refuse: \$82.47

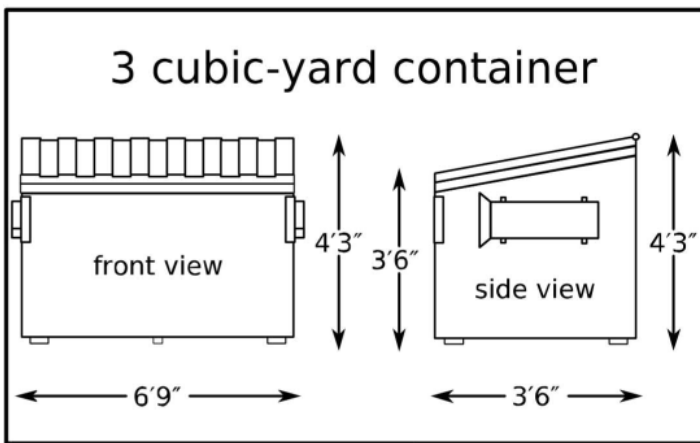

3 Cu Yd Refuse: \$121.65

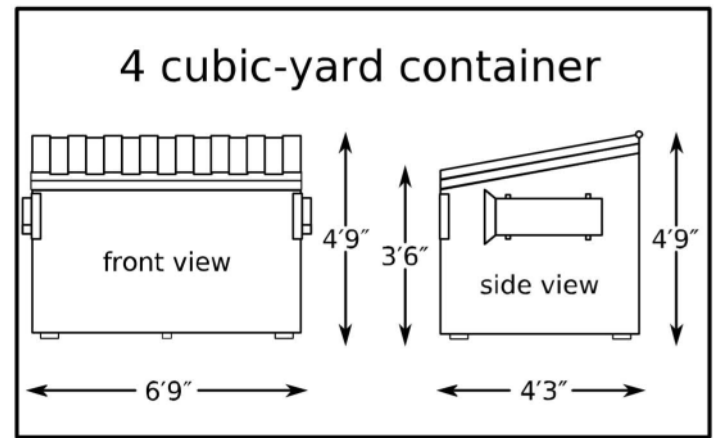

4 Cu Yd Refuse: \$160.83

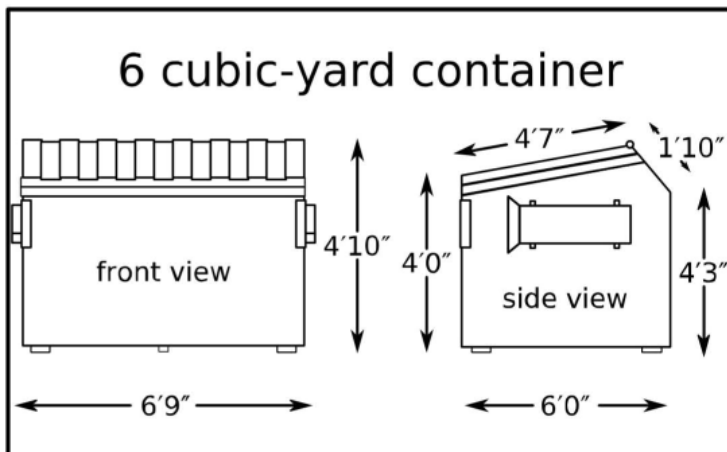

6 Cu Yd Refuse: \$239.21

Front Load Container Illustrations are Approximate Dimensions Only.

Dimensions are Outside Dimensions for Space Requirements.

City of Watsonville Solid Waste Division

30 Day Debris Container Services

Payment Options:

Charge your City of Watsonville Utility Account, Cash, Check, Visa, Master Card or Discover

Additional Charges Apply For:

Unacceptable Materials, Additional Days (Over 30 days) and Overloaded Containers

Unacceptable Materials:

Carpet, Medical Waste, Tree Trunks/Branches Exceeding 6 Inches in Diameter, Electronic Waste, Appliances, Mattresses, Tires, Hazardous Materials (paint, oil, chemicals, etc.)

Material Limitations Apply to:

Delivery of a 2 Cu Yd for: Dirt, Concrete, Tar & Gravel and Roofing Material

Delivery and Pick Up:

Delivery and Pick-up times are between 5:00 a.m. and 1:00 p.m., Monday through Friday, including holidays. Service requests must be made one (1) business day in advance. Boxes will only be placed over paved surfaces. Debris containers may damage driveways and/or parking lots, the City assumes no responsibility for damages.

Loading Box:

Contents of the containers must not exceed the rim of the container and/or lids must close.

Cancellations:

All cancellations must be made one (1) business day in advance of your scheduled delivery or pick-up. You must speak to a representative to ensure cancelation. An additional fee may be charged if not enough notice is given.

Approximate Container Visual Dimensions

1 Cubic Yard

6 Cubic Yard

